



1008401100

IPDMHB-V2

IP Desk Master with Handset V2



- ✓ Compatible with ICX-AlphaCom, AlphaCom, IC-EDGE and iPBXs (SIP)
- ✓ Large high contrast display with backlight for excellent readability
- ✓ Four dynamic navigation keys for quick access to system menus and directory entries.
- ✓ Ten DAK keys provide single-touch access to stations, group calls, audio monitoring, public address zones, radio channels and telephone lines
- ✓ Remote software upgrade, configuration and monitoring
- ✓ ONVIF Compatible
- ✓ Integrated data switch with advanced networking and security functions
- ✓ Powered from the IP network cable using Power over Ethernet (PoE)
- ✓ Superb audio quality – high bandwidth codec, active noise cancellation, acoustic echo cancellation and high output power amplifier

 HD Voice  Active Noise Cancelling  Open Duplex

Description

The IPDMHB-V2 IP Desktop Master with handset is a general purpose intercom station intended for use where a desktop station is the most practical choice. It features a large high contrast display with backlight which allows important information about connections to be shown very clearly.

The IP station supports open standards and is compatible with ICX-AlphaCom, AlphaCom, IC-EDGE and with iPBXs by using SIP technology. When working in ICX-AlphaCom mode, the IP station supports special services only available using the CCoIP protocol. Examples of such services are emergency broadcast with volume override, CCTV integration, call priority, AlphaNet multisite networking and event scripting.

Like all Zenitel stations, this IP desktop station features superb audio quality. This is enabled through a set of advanced technologies such as active noise filtering, acoustic echo cancellation, a wide band audio codec, and high power audio output.

The IP station has an integrated managed data switch providing advanced networking and security features. The integrated switch provides support for:

- ✓ Protection from unwanted access
- ✓ Quality of Service (QoS) by managing data traffic
- ✓ Cost efficient installation by providing shared network connections

To provide maximum availability the station comes with advanced supervision functions. The station line test will detect if there is any faults in the network or station electronics. In addition the station supports tone test, which tests the complete transmission path including microphone and speaker. The status of the stations is reported to AlphaWeb as well as to 3rd party management systems using SNMP, Syslog or OPC.

See also: [additional documentation on wiki.zenitel.com](http://wiki.zenitel.com)

Technical Dimensions

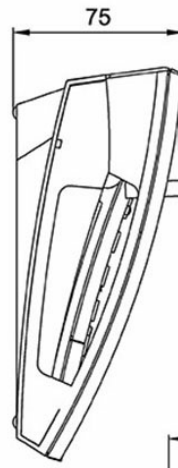
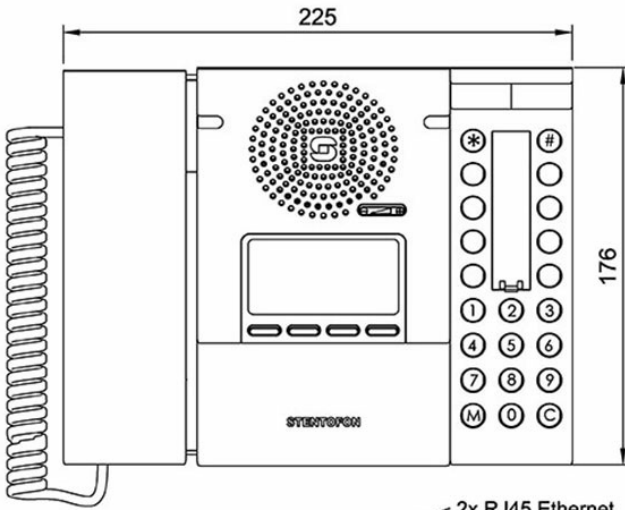

Wall bracket O.no. 1008091100
(optional)

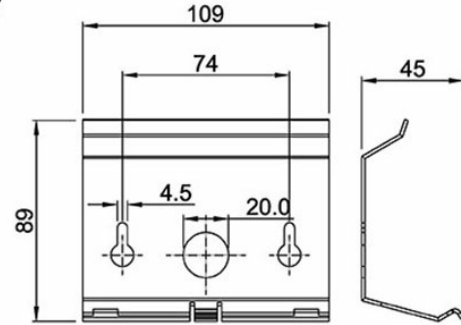
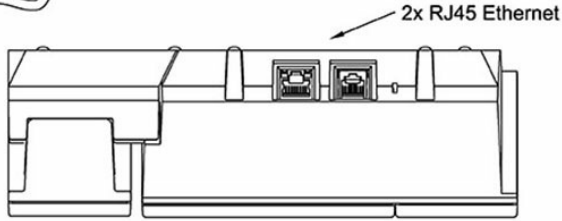

Specifications

GENERAL

Dimension (WxHxD)	225 x 75 x 176 mm
Weight	0.7 kg
Display	Backlit display, 35 x 68 mm (64 x 128 pixels)
Temperature range	0°C - 55°C
Relative humidity	< 95% not condensing
IP Rating	IP-22
Power consumption	Power over Ethernet, IEEE 802.3 a-f, Class 0 Idle 4W, max. 8W
Connectors	2 x RJ45 (Ethernet) 10/100 Mbps
SIP	RFC 3261, SIP Info (DTMF), RFC 2833 (DTMF)
IP protocols	IP v4 - TCP - UDP - HTTPS – TFTP - RTP - RTCP -DHCP - SNMP - DiffServ - TOS – ONVIF - CC oIP® - SIP - RSTP
LAN protocols	Power over Ethernet (IEEE 802.3 a-f), Network Access Control (IEEE 802.1x)
Audio technology	Wideband 200 Hz - 7 kHz (G.722) Telephony 3.4kHz (G.711) Active noise filtering Acoustic echo cancellation Active noise filtering Telephony 3.4kHz (G.711) Wideband 200 Hz - 7 kHz (G.722)
Audio output	1.5 Watt, 85 dB audio pressure 1m from speaker
Management and operation	HTTPS (Web configuration) DHCP and static IP Remote automatic software upgrade Centralized monitoring Status LED
Advanced features	Dual port managed data switch supporting VLAN and network access control
Compliance	CE and FCC Part 15
Warranty	2 Years standard warranty, extendible up to total of 5 years (additional fee)

Accessories



Wall Bracket for Desktop